

ELS-1150

Compact Electro Optic Level Switch available in Nickel-Plated Steel or Stainless Steel

The enhanced ELS-1150 series is the highest performing electro optic level switch from Gems Sensors. At just 1.38" long, the ELS-1150 has been upgraded with a micro processor board design to provide a wide range of capabilities including sinking and sourcing and time delay outputs. The strong fused glass prism eliminates leak potential and is capable of handling extreme temperature and pressure applications up to 2500 psi. The ELS-1150 explosion-proof series is available in versions with wide voltage ranges (see ELS-1150XP). Built with solid state reliability, the sensor is available at an affordable price in Nickel-Plated Carbon Steel or Stainless Steel. The compact size of the sensor makes them ideal candidates for monitoring the small, pressurized vessels found in HVAC, refrigeration and hydraulic applications in Oil and Gas. The sensors are most commonly used for low, high and intermediate level detection in a variety of media.

The stainless steel version (ELS-1150SS) is excellent for application requiring corrosion resistance and is ideal for acids, solvents and dielectric water applications. An explosion proof version, ELS-1150XP, is excellent for applications in Oil & Gas that require small, accurate level sensing of constant media (ie. hydraulic fluid or coolant).

* Higher temperature versions available up to 125°C.
Contact our factory experts for additional ordering information.

Applications

- Hydraulic and lubricating oil reservoirs
- Corrosive liquids such as: acids, solvents, and dielectric water applications
- Critical fluid level monitoring on machine tools, compressors, chillers and other industrial OEM equipment
- Medical Equipment; Anesthesia, Histology

Specifications

Mounting	1/2" NPT, 3/4"-16 Straight Thread
Materials	
Housing	Nickel-Plated Carbon Steel or Stainless Steel
Prism	Fused Glass
Operating Pressure	0 to 2500 PSI, Maximum
Operating Temperature*	-40°F to +212°F (-40°C to +100°C)
Current Consumption	~45 mA
Output	Open Collector Output, 18 mA Sink, Max.
Electrical Termination	22 AWG, Polymeric, 12" to 14" Extended Lead Wires
Repeatability	±1 mm
Approvals**	CE, UL File No. E108913, CUL

* These switches are not for use in freezing liquid or steam/high condensation environments. For higher temperature versions up to 257°F (125°C), and for other alternate requirements, contact Gems factory.

** Carbon Steel model only.

Wiring Diagrams - Typical

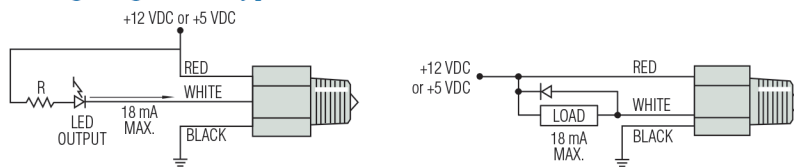

Note: Inductive loads must be diode suppressed.

How To Order

Specify Part Number based on Input Power/ Output Condition and material required.

Input Power	Probe Condition at Current Sink	Nickel-Plated Steel Housing		Stainless Steel Housing
		1/2" NPT Mounting	3/4" - 16 Straight Thread	1/2" NPT Mounting
5 VDC	Wet	194469 ⚡	195201	205486
	Dry	194470	195202	205487
12 VDC	Wet	194471 ⚡	195203	205490 ⚡
	Dry	194472 ⚡	195204	205495

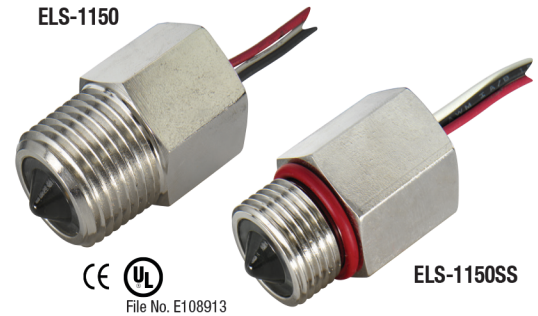

Dimensions

1/2" NPT Mounting

3/4" - 16 Straight Thread Mounting

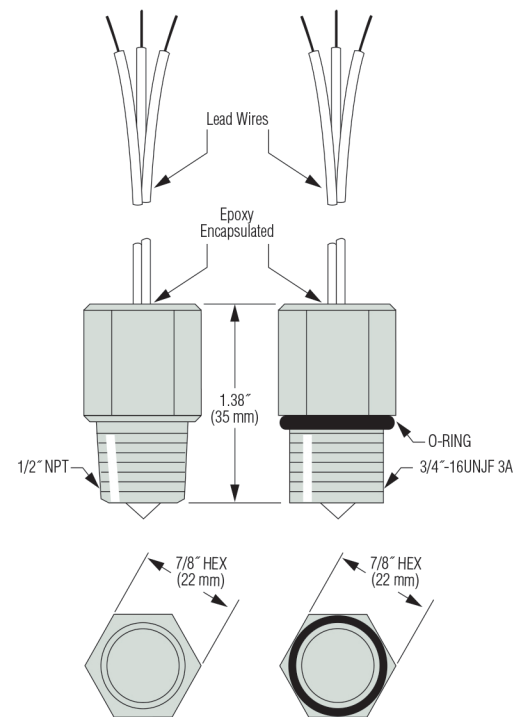

Mounting Attitude

These units must be mounted horizontally or up to 45° from horizontal only.

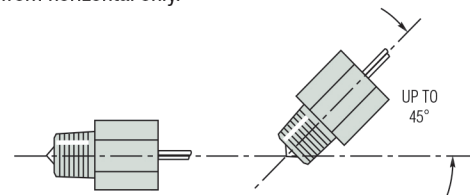

Extended Power and Switching Capabilities of 12 VDC Models with Gems.

Converts TTL output signal to 5 Amp relay output. Available as open circuit board or mounted in a NEMA 4X enclosure (pictured). See Page A-33.



ELS-1150XP

FM-Approved Explosion-Proof

The explosion-proof ELS-1150XP series is designed for use in areas containing flammable bases or vapors in quantities sufficient to produce explosive or ignitable mixtures. It is FM-Approved for use with virtually all hydrocarbon based liquids, as well as with combustible atmospheres containing dusts of coal, coke, flour, starch or other grain.

These solid-state level sensors are available in nickel-plated carbon steel or stainless steel. The strong fused glass prism eliminates leak potential and is capable of handling high temperature and pressure applications up to 5000 psi. The compact size of the sensor makes them ideal candidates for monitoring the small, pressurized vessels found in oil, gas and petrochem environments.

Applications

- Storage Tank Level Monitoring
- Remote Level Monitoring
- Chemical Injection
- Well Head Automation

Specifications

Mounting	1/2" NPT
Materials	
Housing	Nickel-Plated Carbon Steel or Stainless Steel
Prism	Fused Glass
Operating Pressure	0 to 5000 PSI, Maximum (10000 PSI Proof)
Operating Temperature	-40°F to +257°F (-40°C to +125°C)
Input Voltage	5-28 VDC ±5%
Current Consumption	~1 mA
Output	Open Collector Output, 100 mA Sink @ 30VDC, Max.; 100 mA Source, Max.
Electrical Termination	18 AWG, Polyester, 6ft ±2" Extended Lead Wires
Approvals	FM Approved Class I, Div. I Groups A, B, C, D Class II/III, Groups E, F, G

Dimensions

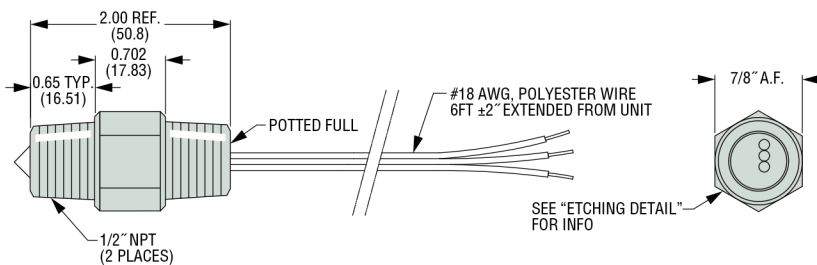

How To Order

Specify Part Number based on Output Logic State and material required.

Output Logic State	Nickel-Plated Steel Housing	Stainless Steel Housing
Wet - Sink	227201	227257
Dry - Sink	227202	227256
Wet - Sourcing	227203	227255
Dry - Sourcing	227204	227254

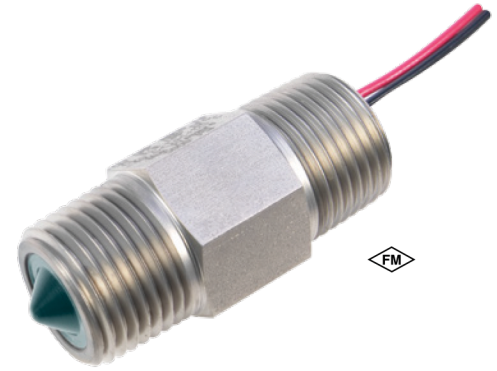

Wiring Diagrams - Typical

Sinking

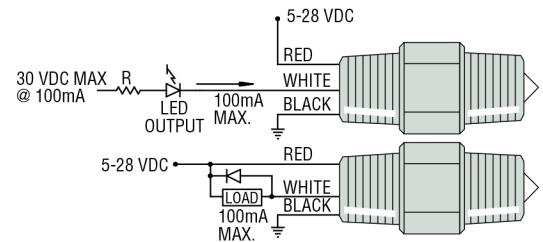

Sourcing

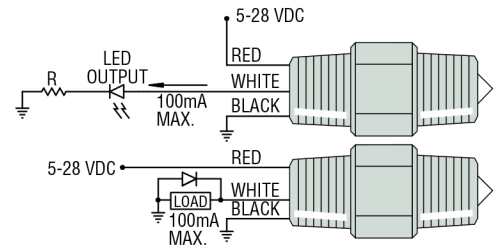

Note: Inductive loads must be diode suppressed.

Mounting Attitude

These units must be mounted horizontally or up to 45° from horizontal only.

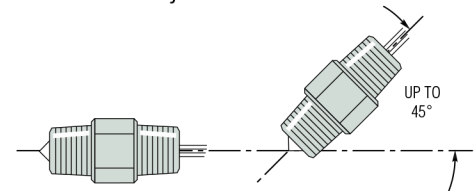

Extended Power and Switching Capabilities of 12 VDC Models with Gems.

Converts TTL output signal to 5 Amp relay output. Available as open circuit board or mounted in a NEMA 4X enclosure (pictured). See Page A-35.



LEVEL SWITCHES - SINGLE POINT